

Piattaforme Cingolate

eva
NOLO

Ragno 30 MT CELA



Ragno 30 MT CELA

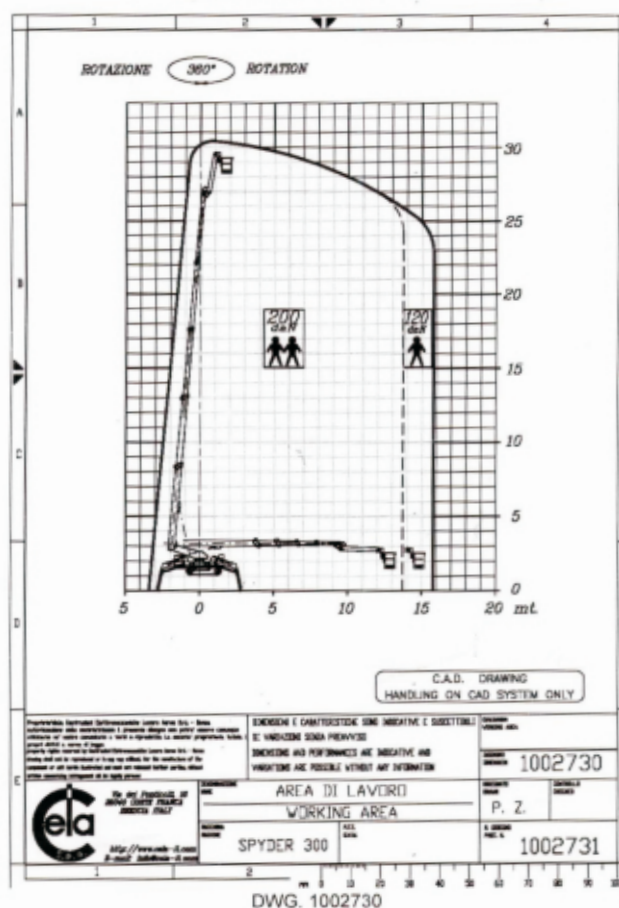

1. DIMENSIONI E PRESTAZIONI

1.1 Veicolo in posizione di marcia

Altezza	mt	2.330
Lunghezza	mt	7.370
Larghezza (cingoli)	mt	1.500
Peso complessivo a terra	daN	7620

1.2 Veicolo in posizione di lavoro

Altezza max. Piattaforma operativa piano calpestio	mt	27
1° raggio d'azione max piatt. operativa	mt	13.5
portata max nel cesto	daN	200
2° raggio d'azione max piatt. operativa	mt	15.2
portata max nel cesto	daN	120
Pressione specifica max. Trasmessa al terreno dai piedi stabilizzatori	daN/cm ²	18
Pressione circuito idraulico	bar	220
Tempo salita completa 1° braccio	sec	68
Tempo salita jib	sec	55
Tempo rotazione 360°	sec	160
Tempo sfilo completo prolun.	sec	50
Tempo rientro completo prolun.	sec	49
Tempo discesa jib	sec	65
Tempo discesa completa 1° braccio	sec	53
Piattaforma		1400x700x (h)1100







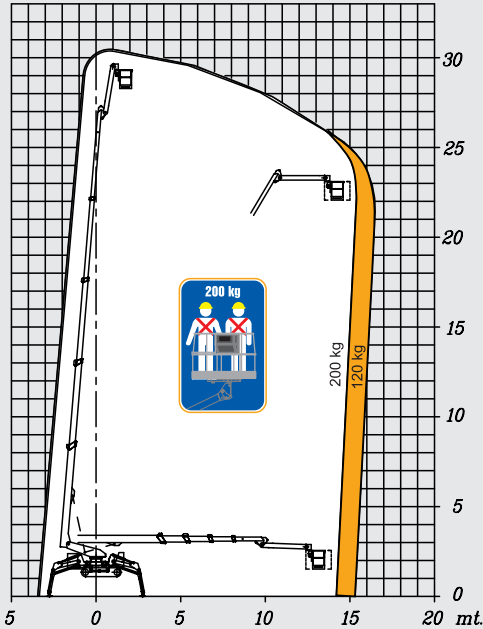



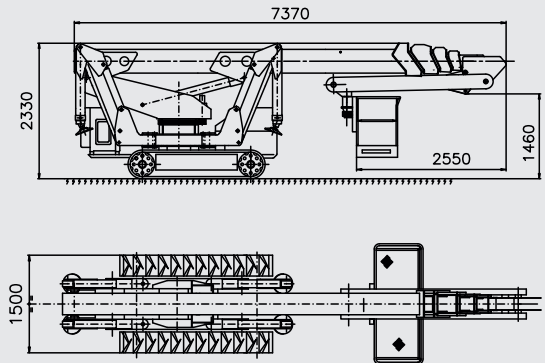

Spyder **300**





Spyder 300



 30,00 m	 28,00 m	 16,50 m	 360°
 90° + 90°	 200 kg	 1800x600x1100 mm	 DANFOSS
			 ALLUMINIO ALUMINIUM ALUMINIUM ALUMINIUM



Cela Srl

Via dei Ponticelli, trav. 1 ^ 2/4 - 25040 Corte Franca (BS)
Tel. +39 030 9884084 r.a. - Fax +39 030 984515 - info@cela-it.com

www.cela.it